

TECHNICAL DATA

Three Phase Electric Motors - Cast Iron Frame

PE30 250 M 2 IE3

55 kW / 75 Cv

2980 RPM

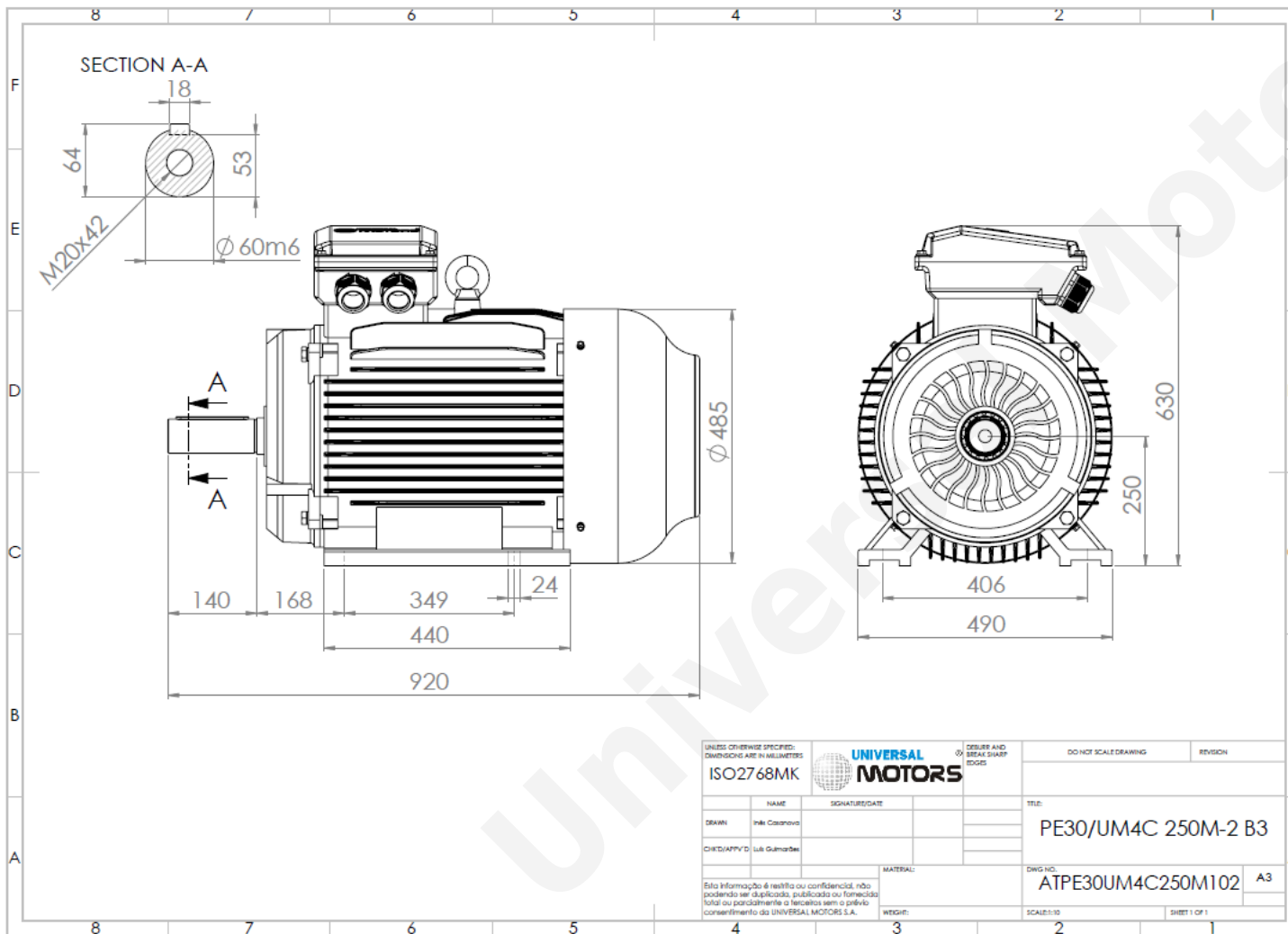

Motor type:	PE30 250 M 2 IE3
Output:	55 kW / 75 Cv
Speed (min ⁻¹):	2980 RPM
Frequency:	50 Hz
Voltage:	400 V
Current:	93.5 A
Power factor (Cos ϕ):	0.90
Poles:	2
Insulation class:	F
Temperature rise Class:	B
Efficiency 50%:	92.9 %
Efficiency 75%:	94.5 %
Efficiency 100%:	94.7 %
Torque:	176 N.m
Tstarting/Tnominal:	2.0
Istarting/Inominal:	7.7
Tmaximum/Tnominal:	2.3
Noise:	89 Db(A)
Weight:	429 Kg
Bearing DE:	6314 C3
Bearing NDE:	6314 C3

Regime - S1

Altitude - 1000m

Environment Temperature - 40°C

CONTACTS:

UNIVERSAL MOTORS Tel: +351 252 299 080
 Rua de São Brás,745 Fax: +351 252 299 089
 4480-782 VILA DO CONDE Mail: geral@universalmotors.pt

* References applied only in the UK